

AN OVERVIEW AND ANALYSIS OF BER FOR THREE DIVERSITY TECHNIQUES IN WIRELESS COMMUNICATION SYSTEMS

Dragan MITI

*Institute for Telecommunications and Electronics,
IRITEL A.D. BELGRADE, Batajnički put 23, 11080
mita@iritel.com*

Aleksandar LEBL

*Institute for Telecommunications and Electronics,
IRITEL A.D. BELGRADE, Batajnički put 23, 11080
lebl@iritel.com*

Branimir TRENKI

*Megatrend University Belgrade, Faculty of Computer Sciences,
Bulevar umetnosti 29, 11070 Belgrade, Serbia
trenkic.branimir@gmail.com*

fiarko MARKOV

*Institute for Telecommunications and Electronics,
IRITEL A.D. BELGRADE, Batajnički put 23, 11080
Zarko.Markov@iritel.com*

Received: November 2013 / Accepted: March 2014

Abstract: The problem of fading refers to a large scale deterioration process of wireless communication channels characteristics. This paper discusses different techniques for mitigating the fading problems. A solution to the problem is to add a fading margin on the transmitter, but it is not an effective solution. The other solution is to use an alternative statistical behavior of fading channels (apply the basic concepts of diversity), which use two or more inputs on the receiver to ensure the correlation of signal. So, the diversity technique is used to improve system performance in fading channels. Instead of transmitting and receiving the desired signal through one channel, we have L copies of the desired signal transferred over M different channels. This paper presents analytical results of the probability of error for diversity techniques which use Rayleigh Fading Channel for BPSK modulation.

Keywords: Diversity, Rayleigh fading channel, Selection combining, Maximum ratio combining, Equal gain combining, Bit error rate (BER), Binary phase-shift keying (BPSK) modulation.

MSC: 32A70, 33E20, 33F05, 65E05, 65D18.

1. INTRODUCTION

In wireless communications, each wave interaction with the objects in the propagation environment results in a large number of sent signal replicas with different attenuation, phase shift, and delay arriving to the receiver input. The superposition of these replicas at the receive side, and the mobility of transmitters and/or receivers, cause time-variability of the received signal amplitude, i.e. at the receive side signal there are amplification or signal attenuation. This phenomenon is referred to, in the literature, as fading [8].

Rayleigh, Rice, Nakagami-m, Nakagami-q and Weibull distribution [8], [7] are commonly used for modeling signal propagation in environments with multiple signal paths, which depend greatly on fading phenomenon. The application of specific model is conditioned by the specific propagation environment. Rayleigh channel model is used in situations where there is no direct line-of-sight (LOS) between the transmitter and the receiver. This is typical for urban environments. Rice model is used in the inter-city areas and suburban areas, where LOS exists [14]. Variations in the instantaneous strength of the received signal in urban areas can be quite well described by Nakagami-m and Weibull distribution [10]. Shadow effect in fading channels involves fluctuations of the level of average signal power; it is a characteristic of larger propagation areas. These fluctuations are usually modeled by log-normal or gamma distribution [8]. In this paper Rayleigh channel model is selected due to its simplicity and frequent use.

In order to improve the system performance in the case of significant fading different methods are used, but diversity techniques are most frequently applied [10], [13]. Diversity transmission is based on the principle of using multiple copies of the transmitted signals that are statistically independent. The most commonly used techniques of combining signals after application of diversity techniques are: Selection Combining, SC, (which means a choice of branch with the best signal-to-noise ratio), Maximum Ratio Combining, MRC, (or combining with a maximum signal-to-noise ratio), Equal Gain Combining, EGC, (combining with the equal contribution of all branches), Switch and Stay Combining, SSC, (simple combining by switching the signals), as well as various hybrid techniques of signal combining.

The most commonly used performance indicators of diversity receiver in fading environments are the mean output signal-to-noise ratio (SNR) or signal-to-interference (SIR), so as the probability of system failure (P_{out}) and bit error rate (BER) [8]. Since the calculation of performance indicators is dependent on the probability density function (PDF) of the received signal, it is important to determine the specificity of this function for a considered propagation environment. Cumulative distribution function (CDF) is calculated by integrating PDF. CDF is used to determine probability of system failure for specific threshold level. In the literature, there are different models for generating Rayleigh fading.

Performances of Rayleigh fading channels were analyzed in different propagation conditions, simulated by changing the number of multiple propagation paths, varying Doppler frequency and time delay of fading path, for different modulation techniques. Since better performances are achieved by the implementation of BPSK modulation format (compared with constellations such as QPSK, 8-PSK, or 4-QAM, 16-QAM) [8], BPSK modulation format is chosen, and BER is used as a numerical indicator of performance.

In order to improve the system performance, diversity techniques with SC, EGC and MRC combining of signals at the receive side were used. The comparative analysis of the techniques being used is performed. To illustrate the results, we analyzed the cases of one, two, three, and six branches of diversity, not only because of the potential required by the simulation process but also because the effective gain of further increase of the number of branches is very small.

2. MODEL OF RAYLEIGH FADING CHANNEL

Rayleigh channel model is commonly used to model fading and statistics of signal, which is transmitted in an environment where there is no line of sight between the transmitter and the receiver. This model is very suitable for the description of the received signal statistics in urban areas and city areas with tall buildings. Rayleigh distribution describes the PDF [10]:

$$p(\alpha) = \frac{2 \cdot \alpha}{\Omega} \cdot \exp\left(-\frac{\alpha^2}{\Omega}\right) \quad (1)$$

where α is a random variable representing the amplitude of the signal, while the average power of this random variable is indicated by Ω . The instantaneous value of the SNR per bit, γ , defined as the ratio of energy per bit E_b scaled by parameter channel fading, and spectral density of noise power N_0 can be described by the distribution [10]:

$$p(\gamma) = \frac{1}{E_b / N_0} \cdot \exp\left(-\frac{\gamma}{E_b / N_0}\right). \quad (2)$$

Performance of Rayleigh fading channels were analyzed in different propagation conditions, which were simulated by changing the number of multiple propagation paths, varying Doppler frequency and time delay.

In each of the diversity branches, noise is modelled by Gaussian PDF [8]:

$$p(n) = \frac{1}{\sqrt{2 \cdot \pi \cdot \sigma^2}} \cdot \exp\left(-\frac{(n - \mu)^2}{2 \cdot \sigma^2}\right), \quad (3)$$

where the mean $\mu=0$, variance $\sigma^2=N_0/2$ and n is the Additive White Gaussian Noise (AWGN). In each of the diversity branches, the instantaneous value SNR per bit, γ_i , is modelled by the distribution (2). On the receive side, equalization of the received signal by the known complex channel parameter is performed, and selection, in accordance with

the rules of the selected signal for combining techniques (MRC, EGC or SC), is analyzed. After decoding is done, error probabilities are calculated [8] as:

$$P_e = \int_0^{\infty} \frac{1}{2} \operatorname{erfc}(\sqrt{\gamma}) \cdot p(\gamma) \cdot d\gamma \quad (4)$$

3. DIVERSITY TECHNIQUES

Diversity techniques can be used to improve system performance in fading channels. Instead of transmitting and receiving the desired signal through one channel, L copies of the desired signal through M different channels are received. There are several different types of diversity techniques that are commonly used in wireless communication systems [9], [3], [1], [16], [17], [11].

3.1. Frequency diversity

The first approach to achieve diversity is to modulate an information signal by M different carriers, Figure 1, where $s(t)$ is the equivalent lowpass of the transmitted signal, and W is weighting factor.

Each carrier must be separated from the other one to achieve minimal coherence between transmission bands $(\Delta f)_c$, so that different copies of the signal are received as independent fading. At the receiver, L independent fading copies are "optimally" combined to give a statistical decision. Optimal manipulator is the maximum ratio of combination, which will be described later. Frequency Diversity can be used to suppress frequency selective fading.

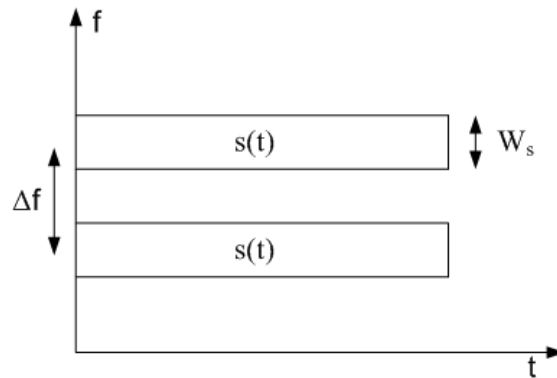

Figure 1: Frequency diversity

3.2. Time diversity

Another approach to achieve diversity is to transmit the desired signal in M different time periods, i.e., each symbol is transmitted M times, Figure 2, where $s(t)$ is the equivalent lowpass of the transmitted signal, and W is weighting factor. The intervals between the transmission of the same symbol should be determined in such a way to achieve the least coherence of time intervals $(\Delta t)_c$ so that different copies of the same symbols undergo independent fading. The optimal combination can be obtained by the maximum ratio of combinations. We notice that sending the same symbol M times is as applying the $(M,1)$ repetition code. In fact, non-trivial coding can be also used. Error control coding with interlacing can be an effective way to combat time selective (fast) fading.

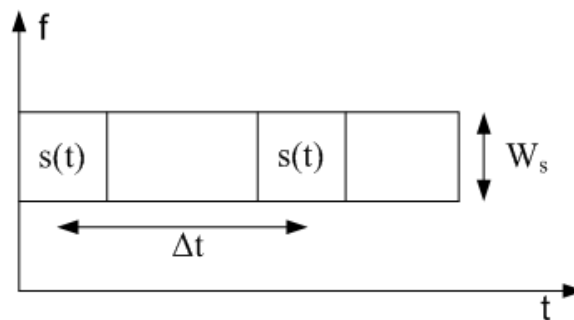

Figure 2: Time diversity

3.3. Space diversity

The third method to achieve diversity is to use M antennas to receive M copies of transferred signal, Figure 3.

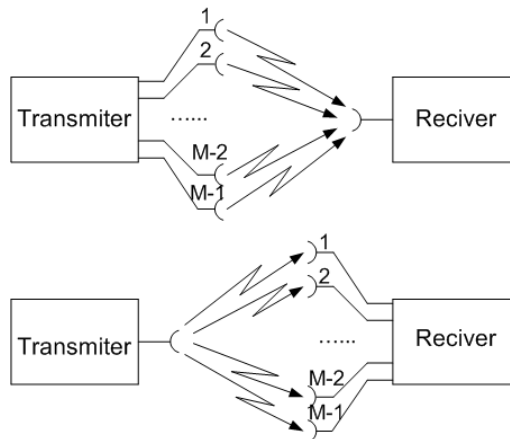

Figure 3: Space diversity

The antennas should be located far enough from each other to achieve that received copies of the signal have independent fading. Unlike frequency diversity and time diversity, it is not necessary to have additional processing at the end of transmission. It is not necessary to reserve additional transmission band or additional transmission time.

Therefore, there are physical limitations for using space diversity. Sometimes, several transmission antennas are also used to send several copies of transmitted signal. Space diversity can be used to combat against both types of fading, frequency fading and time fading.

4. DIVERSITY COMBINING METHODS

The idea of diversity is to combine several copies of the transferred signal passing independent fading in order to increase total receiving power. Different types of diversity provide different methods of combining. In this paper, we review some common methods of diversity combining.

For slow flat fading channel, the equivalent low-pass received signal for the branch i can be written as:

$$r_i(t) = A_i e^{j\theta_i} \cdot s(t) + z_i(t), \quad i = 0, 1, \dots, M-1,$$

where $s(t)$ is equivalent to low-pass transmitted signal, $A_i e^{j\theta_i}$ the fading attenuation for the branch i , $z_i(t)$ is Additive White Gaussian noise, AWGN.

M replicas of transferred signal are obtained from M branches:

$$r = [r_1(t), r_2(t), \dots, r_{M-1}(t)].$$

4.1. Selection Combining, SC

SC is the simplest and most commonly used method for combining signals in Diversity system, which is based on choosing the branch with the most favourable SNR, Figure 4. SC receiver estimates the current value of SNR in all branches and selects the one with the most favourable SNR [16], [17], [11].

Combining the outputs, it is obtained

$$y(t) = A_i e^{j\theta_i} \cdot s(t) + z_i(t), \quad \text{with } A = \max\{A_0, A_1, \dots, A_{M-1}\}.$$

Received SNR can be written as follows:

$$\Gamma = \frac{A^2 \cdot E_b}{N_0} = \max\{\Gamma_0, \Gamma_1, \dots, \Gamma_{M-1}\}.$$

With uncorrelated branches, the CDF for i.i.d (independent and identically distributed) branch is:

$$p_\Gamma(\gamma) = M \cdot p_{\Gamma_0}(\gamma) [P_{\Gamma_0}(\gamma)]^{M-1}.$$

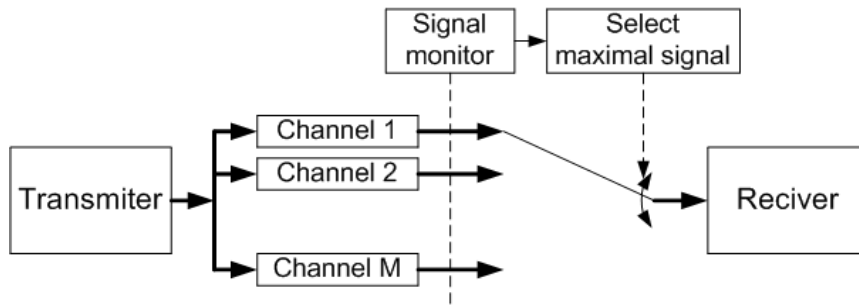

Figure 4: Selection Combining

The following example is given for the Rayleigh Fading Channel. Probability is expressed by equation (5), and is presented in Figure 5, for $M = 1, M = 2, M = 3, M = 6$ (M is the number of antennas):

$$P_T(\gamma) = (1 - e^{-\gamma/\gamma_0})^M, \gamma_0 = 2 \cdot \sigma^2 \cdot E_b / N_0. \tag{5}$$

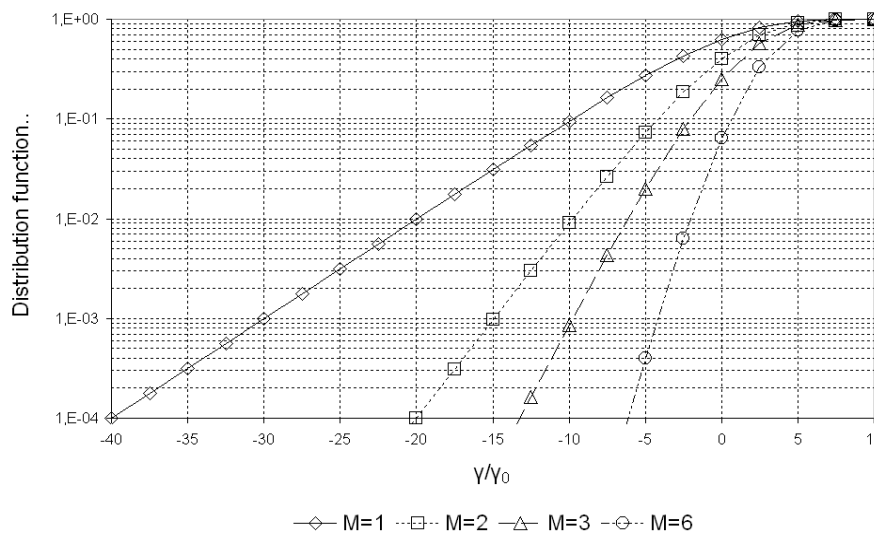

Figure 5: Selection Combining in Rayleigh Fading Channel for the case of M receiving antennas

4.1.1. Outage probability in Selection Combining

In order to analyze the probability of bit error (BER), let us first find the probability of failure for the i^{th} on the receiving antenna [5], [2]. Probability of failure is

the probability that the ratio of bit energy to noise drops below a given threshold. Probability of failure, i^{th} on the antenna reception, is:

$$P_{out,\gamma_i} = P[\gamma_i < \gamma_s] = \int_0^{\gamma_s} \frac{1}{(E_b/N_0)} \cdot e^{\frac{-\gamma_i}{(E_b/N_0)}} d\gamma_i = 1 - e^{\frac{-\gamma_s}{(E_b/N_0)}},$$

where is: γ_s defined threshold for the ratio of bit energy to noise.

In the case that we have M receiving antennas, and if assumed that the channel for each antenna is independent, the joint probability is the product of the individual probabilities

$$P_{out} = P[\gamma_1 < \gamma_s] \cdot P[\gamma_2 < \gamma_s] \dots P[\gamma_i < \gamma_s] = \prod_1^M P[\gamma_i < \gamma_s] = \left[1 - e^{\frac{-\gamma_s}{(E_b/N_0)}} \right]^M.$$

Note that the above given equation defines the probability that the effective ratio of bit energy to noise for M receiving antennas (let's take label γ) is less than the threshold γ_s . This is actually cumulative distribution function (CDF) of γ . Probability density function (PDF) is then obtained as the derivative of the CDF:

$$p(\gamma) = \frac{dP_{out}}{d\gamma} = \frac{M}{(E_b/N_0)} \cdot e^{\frac{-\gamma}{(E_b/N_0)}} \left[1 - e^{\frac{-\gamma}{(E_b/N_0)}} \right]^{M-1}. \quad (6)$$

With selective Diversity, we have seen that the effective SNR is improved, but it is not improved linearly with the number of receive antennas; the improvement is reduced when the number of antennas is increased, Figure 13.

4.1.2. Bit Error Rate with Selection Combining

If the calculation of BER with AWGN, [8], as a function of bit energy to noise, E_b/N_0 , then the BER for BPSK with AWGN can be defined as:

$$P_b = \frac{1}{2} \operatorname{erfc} \left(\sqrt{\frac{E_b}{N_0}} \right).$$

Considering that the effective ratio of bit energy to noise for the selective diversity is given by γ , the total BER is integral of the conditional BER integrated over all possible values of γ , which can be expressed as:

$$\begin{aligned}
 P_e &= \int_0^\infty \frac{1}{2} \operatorname{erfc}(\sqrt{\gamma}) \cdot p(\gamma) \cdot d\gamma = \\
 &= \int_0^\infty \frac{1}{2} \operatorname{erfc}(\sqrt{\gamma}) \cdot \frac{M}{(E_b/N_0)} \cdot e^{-\frac{\gamma}{(E_b/N_0)}} \left[1 - e^{-\frac{\gamma}{(E_b/N_0)}} \right]^{M-1} \cdot d\gamma
 \end{aligned} \tag{7}$$

This equation is reduced to

$$P_e = \frac{1}{2} \sum_{k=0}^{M-1} (-1)^k \binom{M}{k} \cdot \left(1 + \frac{k}{(E_b/N_0)} \right)^{1/2},$$

(equation 11.24 in Section 11.3.2 [6]).

In Figure 6, we present the BER for BPSK in Rayleigh channel with Selection Diversity. It can be seen that the improvement of the two receiving antennas with respect to the one receiving antenna is about 16dB for BER=10⁻⁴.

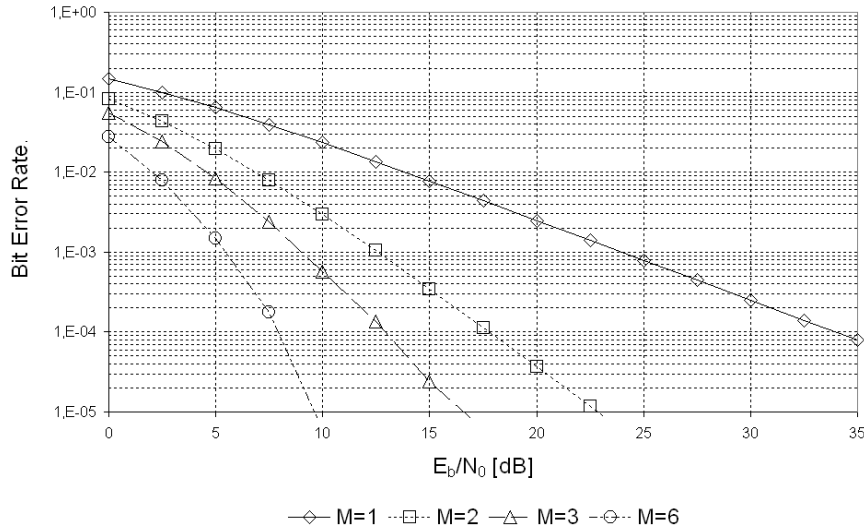

Figure 6: BER plot for BPSK in Rayleigh channel with Selection Diversity for the case of M receiving antennas

4.2. Maximal Ratio Combining, MRC

MRC is the optimal linear technique of signal combination in the Diversity system, which provides the best statistical results in limiting the impact of fading. The signal in each of Diversity branches is, before summarizing, multiplied by the matching weighting factor, thus equating phases of all signals, and the branches with more

favorable SNR are taken with greater contribution, Figure 7. This ensures that the signal with more power has greater contribution in the received sum of signals. Therefore, it is necessary to have measurement of SNR in all branches, and that is why this technique is expensive for practical implementation [4], [18].

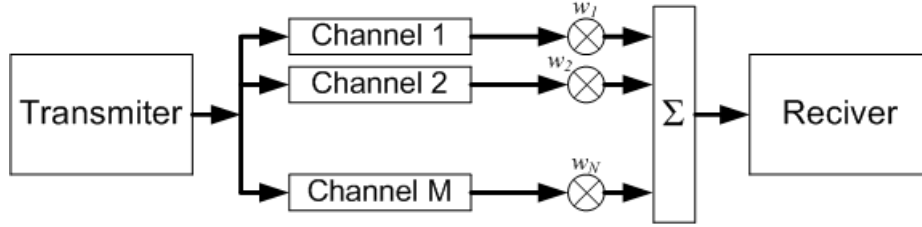

Figure 7: Maximal Ratio Combining

Combined output is expressed by:

$$y(t) = \sum_{i=0}^{M-1} w_i \cdot r_i(t) .$$

Weighting factors are chosen in such a way that channel gain is conjugate (must be estimated):

$$y(t) = \left(\sum_{i=0}^{M-1} A_i^2 \right) \cdot s(t) + \sum_{i=0}^{M-1} A_i e^{-j\theta_i} \cdot z_i(t) .$$

The SNR of the combined signal is:

$$\Gamma = \frac{\sum_{i=0}^{M-1} A_i^2 \cdot E_b}{N_0} = \sum_{i=0}^{M-1} \Gamma_i .$$

For Rayleigh Fading channel, the outage probability is given by (8) and is shown in Figure 8, for M = 1, M = 2, M = 3, M = 6 (M is the number of antennas):

$$P_{\Gamma}(\gamma) = 1 - e^{-\frac{\gamma}{\gamma_0}} \sum_{i=0}^M \frac{(\gamma / \gamma_0)^{i-1}}{(i-1)!} . \tag{8}$$

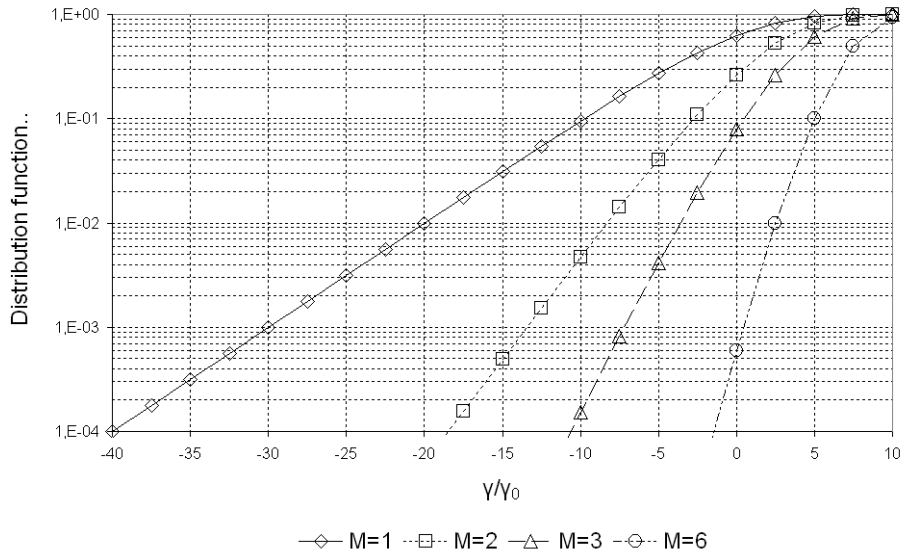

Figure 8: Maximal Ratio Combining in Rayleigh fading Channel for the case of M receiving antennas

4.2.1. Effective Eb/No with Maximal Ratio Combining

In the presence of channel h_i , the current ratio of energy and noise for the i^{th} receiving antenna is:

$$\gamma_i = \frac{|h_i|^2 E_b}{N_0} .$$

Taking into consideration that we equalized all channels and marked them by h_i , the effective ratio of bit energy to noise, for M receiving antennas, is:

$$\gamma = \sum_{i=1}^M \frac{|h_i|^2 E_b}{N_0} = M \cdot \gamma_i .$$

The effective ratio of bit energy to noise in the case M receiving antennas is M times greater than the relationship of energy to noise in the case of one antenna, as presented later in Figure 13.

4.2.2. Bit Error Rate with Maximal Ratio Combining

If we consider the chi-square random variable [8], it is well known that if h_i is Rayleigh distribution of the random variable, then h_i^2 is the chi-square random variable with two degrees of freedom. Then the PDF for γ_i is:

$$p(\gamma_i) = \frac{1}{(E_b / N_0)} e^{-\frac{\gamma_i}{(E_b / N_0)}}$$

Hence, the effective ratio of bit energy to noise, γ , is the sum of M random variables, where the PDF of γ is the chi-squared random variable with 2M degrees of freedom. PDF of γ is:

$$p(\gamma) = \frac{1}{(M-1)! (E_b / N_0)^M} \cdot \gamma^{M-1} \cdot e^{-\frac{\gamma}{(E_b / N_0)}}, \gamma \geq 0. \quad (9)$$

If we designate the relation of bit energy to noise as E_b/N_0 , BER for BPSK with AWGN is expressed as:

$$P_b = \frac{1}{2} \operatorname{erfc} \left(\sqrt{\frac{E_b}{N_0}} \right). \quad (10)$$

If the designate by γ , the efficient ratio of bit energy to noise for the MRC, then using (9) and (10), the total BER is integral, for the conditional BER, calculated over all possible values of γ , as presented in (11):

$$\begin{aligned} P_e &= \int_0^{\infty} \frac{1}{2} \operatorname{erfc}(\sqrt{\lambda}) \cdot p(\gamma) \cdot dy = \\ &= \int_0^{\infty} \frac{1}{2} \operatorname{erfc}(\sqrt{\lambda}) \frac{1}{(M-1)! (E_b / N_0)^M} \cdot \gamma^{M-1} \cdot e^{-\frac{\gamma}{(E_b / N_0)}} \cdot dy \end{aligned} \quad (11)$$

Equation (11) is reduced to

$$P_e = p^M \sum_{k=0}^{M-1} \binom{M-1+k}{k} \cdot (1-p)^k, \quad (12)$$

where is

$$p = \frac{1}{2} - \frac{1}{2} \cdot \left(1 + \frac{1}{E_b / N_0} \right)^{-1/2},$$

(equation 11.12 and 11.13 in section 11.3.1 [6]).

BER for BPSK in Rayleigh channel with Maximal Ratio Combining is presented in Figure 9. From this figure, it can be seen that the improvement for the two receiving antennas, compared to one receiving antenna, is about 13dB for BER=10⁻³.

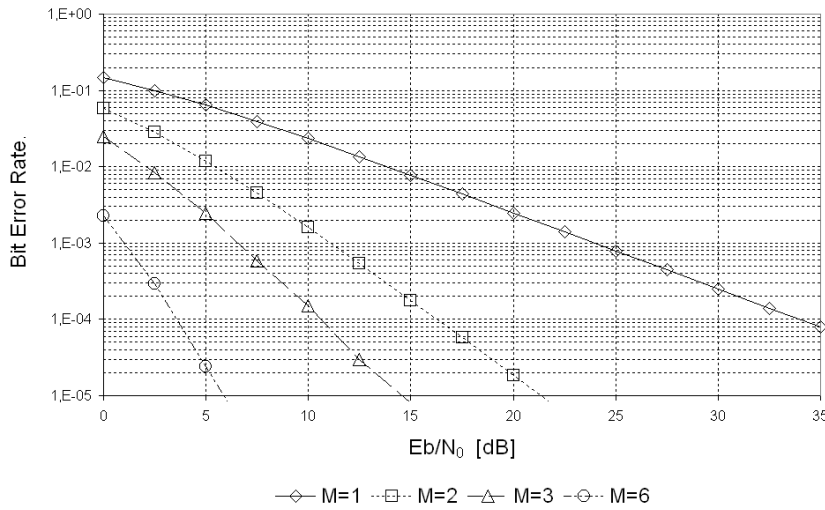

Figure 9: BER plot for BPSK in Rayleigh channel with Maximal Ratio Combining for the case of M receiving antennas

4.3. Equal Gain Combining, EGC

When applying EGC technique of combining signals, phase-changes of signals in all diversity branches are compensated, and then signals are summed, Figure 10. Unlike the MRC technique, all summands have the same weighting factor, so it is not required to measure and estimate SNR in all diversity branches. That's why this technique is simpler and cheaper for practical implementation. Slightly worse performances comparing to MRC techniques implementation are the price of simpler and cheaper practical implementation [17], [11], [12].

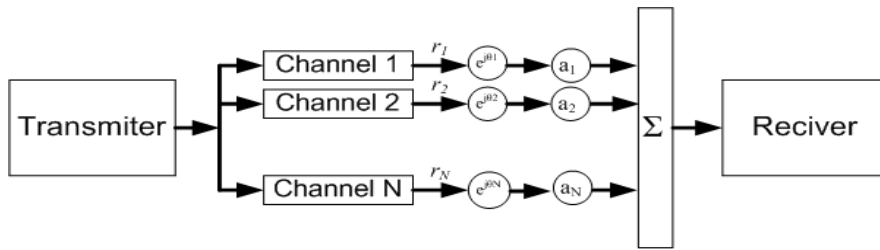

Figure 10: Equal Gain Combining

The average improvement of SNR for EGC is typically about 1 dB worse than for MRC implementation, but it is still much better than without diversity. Each branch of the signal is rotated by $e^{j\theta_i}$, then all branches of signals are summed.

Combined output is expressed as:

$$y(t) = \sum_{i=0}^M e^{-j\theta_i} \cdot r_i(t) = \left(\sum_{i=0}^M A_i \right) \cdot s(t) + \sum_{i=0}^M e^{-j\theta_i} \cdot z_i(t)$$

For Rayleigh Fading channel, the output probability is given by (13) and is presented in Figure 11 for the case of M receiving antennas, (M=1, M=2, M=3, M=6):

$$\Gamma = \left(\sum_{i=0}^{M-1} A_i \right)^2 \frac{E_b}{M \cdot N_0} \tag{13}$$

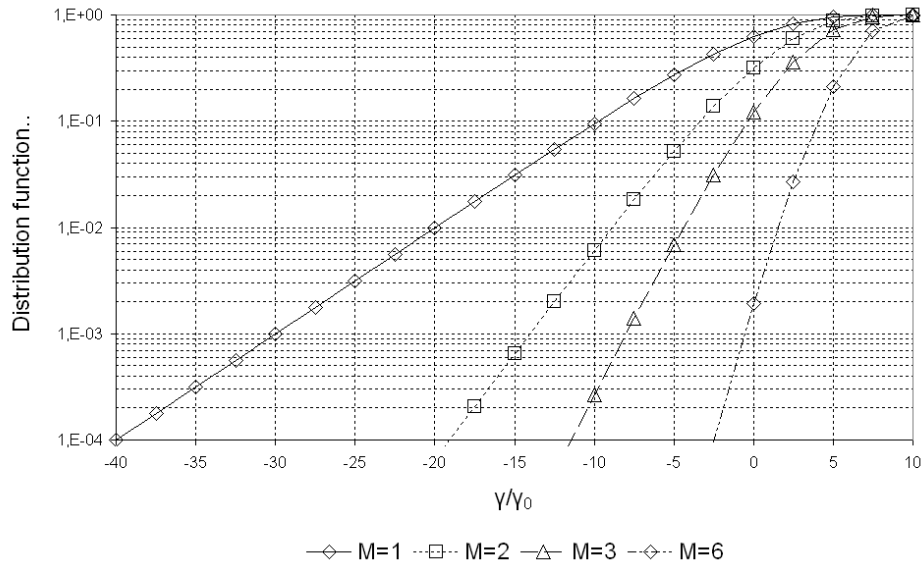

Figure 11: Equal Gain Combining for the case of M receiving antennas

4.3.1. Effective Eb/N0 with Equal Gain Combining

In the presence of channel h_i , [5], [2], the current ratio of bit energy to noise at the receiving antenna is:

$$\frac{|h_i|^2 E_b}{N_0}$$

For convenient notation, let's define γ_i as

$$\gamma_i = \frac{|h_i|^2 E_b}{N_0}$$

Effective E_b/N_0 for EGC is channel power accumulated over all receiving antennas, i.e.:

$$\begin{aligned} E(y_i) &= \frac{E_b}{N_0} \cdot \frac{1}{M} \left(\sum_{i=1}^M |h_i|^2 \right) = \frac{E_b}{N_0} \cdot \frac{1}{M} \left(\sum_{i=1}^M \sum_{k=1}^M |h_i| |h_k| \right) = \\ &= \frac{E_b}{N_0} \cdot \frac{1}{M} \left(\sum_{i=1}^M |h_i|^2 + \sum_{i=1}^M \sum_{k=1, k \neq i}^M |h_i| |h_k| \right) \end{aligned} \quad (14)$$

The first term in (14) is a chi-squared random variable [8] with $2M$ degrees of freedom, and has a mean value of

$$2 \cdot N \cdot \sigma_{h_i}^2.$$

Hence, the first part is reduced to

$$\sum_{i=1}^N |h_i|^2 = M \quad (15)$$

The second part in (14) is the product of two Rayleigh random variables. The mean value of the Rayleigh random variable $\sigma_{h_i}^2$ is $\sigma_{h_i} \cdot \sqrt{\frac{\pi}{2}}$. Hence, the second part is,

$$\sum_{i=1}^N \sum_{k=1, k \neq i}^N |h_i| |h_k| = M \cdot \sqrt{\frac{\pi}{4}} \cdot (M-1) \sqrt{\frac{\pi}{4}} = M \cdot (M-1) \cdot \frac{\pi}{4}. \quad (16)$$

Simplified, if we replace (15) and (16) into (14), the effective E_b/N_0 for EGC is of the form:

$$E(\gamma_i) = \frac{E_b}{N_0} \cdot \frac{1}{M} \cdot [M + M \cdot (M-1) \cdot \frac{\pi}{4}] = \frac{E_b}{N_0} \cdot [1 + (M-1) \cdot \frac{\pi}{4}].$$

Figure 12 presents the ratio of the effective bit energy to the noise in the case M receiving antennas.

4.3.2. Bit Error Rate with Equal Gain Combining

Calculation of the BER for EGC is presented in [15]. The current value of the SNR per bit in the case of EGC techniques in a Diversity system with two branches can be described by the distribution [10]:

$$p_e = \frac{\exp\left(-\frac{2 \cdot \gamma}{E_b / N_o}\right)}{E_b / N_o} + \sqrt{\pi} \cdot \exp\left(-\frac{2 \cdot \gamma}{E_b / N_o}\right) \cdot \left(\frac{1}{\sqrt{4 \cdot \gamma \cdot E_b / N_o}} - \frac{1}{E_b / N_o} \sqrt{\frac{\gamma}{E_b / N_o}} \right) \cdot \left(1 + 2 \cdot Q\left(\sqrt{\frac{2 \cdot \gamma}{E_b / N_o}}\right) \right) \tag{17}$$

where $Q()$ is a Q-function [12] which defines the probability that the Gaussian random variable has a value greater than a defined threshold value. After demodulation, error probability is calculated and, based on (4) and (17) for the case $M = 2$, it is:

$$P_e = \frac{1}{2} \cdot \left[1 - \frac{\sqrt{E_b / N_o \cdot (E_b / N_o + 2)}}{E_b / N_o + 1} \right]$$

BER for BPSK in Rayleigh channel with Equal Gain Combining for the case of M receiving antennas is presented in Figure 12.

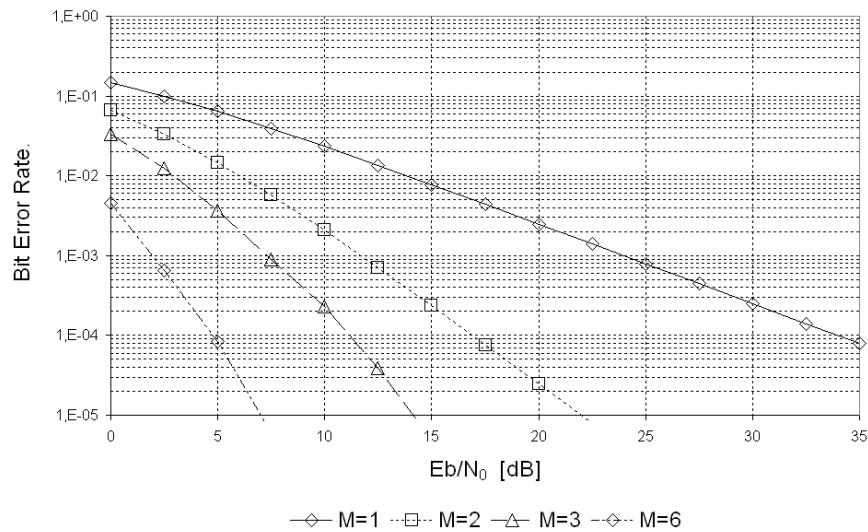

Figure 12: BER plot for Receive Diversity with Equal Gain Combining for the case of M receiving antennas

5. COMPARISON OF THE THREE TECHNIQUES, SC, MRC AND EGC

Here, we compare the techniques for selective combining (SC), maximal ratio signal-to-noise power combining (MRC) and combining with an equal contribution of all branches (EGC) in terms of complexity and improvement of the SNR. In Figure 13 is presented an improvement of the SNR as the function of the number of elements (number of used antennas $M=1, M=2, M=3$ and $M=6$ antennas) for three techniques SC, MRC and EGC.

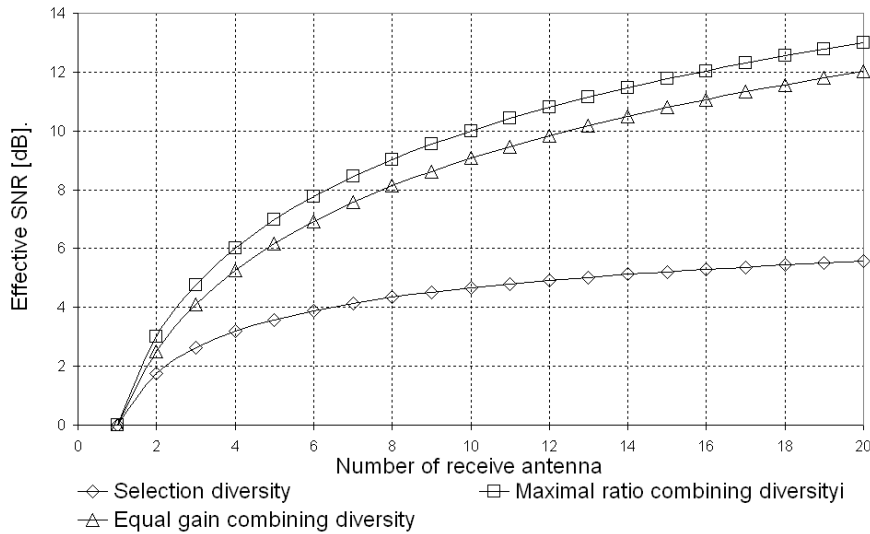

Figure 13: SNR gain with Selection Diversity, Maximal Ratio Combining and Equal Gain Combining

In Figure 14, comparing for Rayleigh Fading channel, the output probability is given by (5) for SC, (8) for MRC and (13) for EGC for the case of M receiving antennas, ($M=1, M=2, M=3, M=6$). As expected, the best improvement is achieved for the technique for combining with maximal ratio of power signal-to-noise (MRC), and the worst is the technique of selective combining (SC). It is important to notice that the improvement in the case of EGC is comparable to MRC.

Considering the necessary resources for the implementation, SC is the simplest, since the technique requires only a measurement of the SNR at each element, not phase or amplitude, i.e. the technique does not have to be coherent. Both techniques, MRC and EGC, on the other hand, require information about the phase. MRC technique requires more precise measurement than EGC. MRC improves performance by about 0.6dB compared with EGC, for the BER=1%.

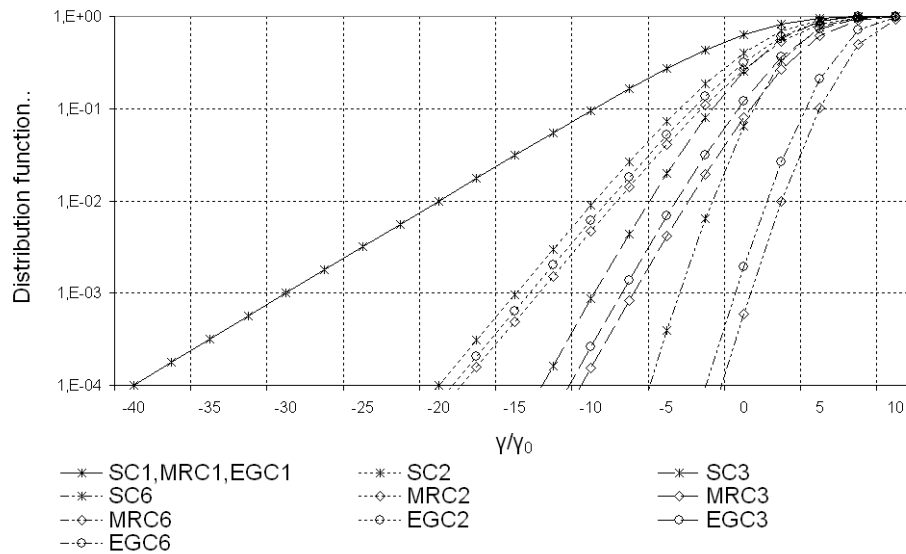

Figure 14: Comparing Selection Diversity (SC1, SC2, SC3, SC6), Maximal Ratio Combining (MRC1, MRC2, MRC3, MRC6) and Equal Gain Combining (EGC1, EGC2, EGC3, EGC6)

6. CONCLUSION

Optimization of the existing and the development of new models of propagation in fading channels, so as the application of various techniques to improve the performance in case of fading existence, are of great importance in planning and developing wireless communication systems. This paper analyzes the characteristics of the Rayleigh channel.

In order to improve system performance, diversity technique was applied with different techniques of signal combining at the receive side. Characteristics have been investigated in the case of receiver, which implements diversity techniques with one, two, three, and six branches, using SC, EGC and MRC techniques of signal combining, using the BPSK with coherent detection of signal. As a measure of performance, we have chosen BER, and concluded that the best performance is achieved by applying the techniques of MRC. Slightly worse performance is achieved by using the technique of EGC, and the worst, by using SC techniques. This is consistent with the analytical results.

Acknowledgements. This work is partially supported by the Ministry of Science and Technological Development of the Republic of Serbia within the Project TR32007.

REFERENCES

- [1] DR. Kamilo Fehar, *Wireless Digital Communications-Modulation & Spread Spectrum Applications*, Prentice Hall India, 2004.
- [2] Godara L.C., *Handbook of Antennas for Wireless Communications*, CRC Press, 2002.
- [3] Hafeth Hourani, *An Overview of diversity techniques in wireless communication systems*, S-72.333 Postgraduate course in radio communication, 2004/2005.
- [4] Jakes Jr.W.C., *Microwave Mobile Communication*, Wiley, New York, 1974.
- [5] Janaswamy R., *Radiowave Propagation and Smart Antennas for Wireless Communications*, Kluwer Academic Publishers, 2000.
- [6] John R. Barry, Edward A. Lee, and David G. Messerschmitt, *Digital Communication*, Third Edition, 2003.
- [7] Lee W.Y.C., *Mobile Cellular Communications*, McGraw-Hill Book Co., New York, 1989.
- [8] Proakis J., *Digital Communications*, Third Edition, McGraw-Hill, 1999.
- [9] Rappaport D., *Wireless Communications Principles and Practice*, Eagle hood Cliffs, NJ: Prentice Hall 1996.
- [10] Simon M.K., and Alouini M.S., *Digital Communications over Fading Channels*, 2nd ed., John Wiley& Sons, New York, NY, USA, 2005.
- [11] Simon M.K., and Alouini M.S., "A Unified Approach to the Performance Analysis of Digital Communication over generalized Fading Channels", *Proc. IEEE*, 86 (9) (1998) 1860-1877.
- [12] Simon M.K., and Alouini M.S., *Digital Communication Over Fading Channels: A Unified Approach to Performance Analysis*, Wiley, New York 2000.
- [13] Stuber G.L., *Principles of Mobile Communications*, 2nd Ed, Kluwer Academic Publishers, 2001.
- [14] Thomas M. Cover, and Joy A. Thomas, *Elements of Information Theory*, 2nd Edition, Wiley-Interscience, 2006.
- [15] Zhang Q.T., "Probability of error for equal-gain combiners over Rayleigh channels: some closed-form solutions", *Communications, IEEE Transactions on* 45 (3) (1997) 2706-2713.
- [16] William C.Y. Lee, *Mobile Communications Design fundamentals*, Wiley Series in Telecommunications, Second edition, 1993.
- [17] William C.Y. Lee, *Mobile Communications Engineering-Theory and Applications*, Second edition, Tata Mc-Graw Hill Publishing Company limited, New Delhi, 2008.
- [18] Winters J.H., "Optimum combining in digital mobile radio with cochannel interference", *IEEE Trans. Veh. Technol.*, VT-33 (1984) 1446-1455.